

UNIVERSAL 240VAC 30A BREWERY / ARDUINO MEGA 2560 INTERFACE

UPDATED: 12-1-17. BruControl (c) 2017.

- SCHEMATIC PROVIDED FOR CONCEPTUAL PURPOSES ONLY. BRUCONTROL MAKES NO CLAIMS REGARDING SCHEMATIC INTEGRITY, ACCURACY, SAFETY, OR ADHERENCE TO DOCUMENTED SAFETY STANDARDS. USER ASSUMES ALL LIABILITY REGARDING SCHEMATIC, COMPONENT SELECTION, AND FITMENT TO TASK BY REFERENCING IT IN ANY MANNER. BRUCONTROL ASSUMES NO RESPONSIBILITY FOR THIS SCHEMATIC'S INTERPRETATION, IMPLEMENTATION, SUITABILITY, OR MODIFICATION, INDEPENDENT OF WHETHER CONDUCTED BY A PRIVATE OR COMMERCIAL ENTITY.
- ALL COMPONENTS AND INSTALLATION PRACTICES MUST MEET APPLICATION CRITERIA AND FOLLOW STANDARDS DOCUMENTED IN THE NATIONAL ELECTRIC CODE, APPLICABLE GOVERNING BODIES, OR LOCAL BUILDING CODES, WHICHEVER HOLD PRIORITY AUTHORIZATION.
- SCHEMATIC, WIRING, ENCLOSURE, AND COMPONENTS MUST BE REVIEWED AND APPROVED BY A CERTIFIED PROFESSIONAL PRIOR TO USE.
- SUPPLY POWER MUST BE PROVIDED VIA A GFCI PROTECTED, 240 VAC, 50/60HZ, 30A SOURCE, PROPERLY TERMINATED ACCORDING TO APPROPRIATE BUILDING CODES. ALL COMPONENTS MUST BE APPROPRIATELY GROUNDED, INCLUDING ANY ELECTRICALLY CONDUCTIVE ITEMS OUTSIDE CONTROL PANEL ENCLOSURE, INCLUDING VESSELS WHICH HOLD LIQUID.
- CONTROL PANEL MUST NEVER BE POWERED WITH AN OPEN ENCLOSURE OR IN ANY MANNER WHERE PERSONNEL CAN ACCESS LIVE POWERED CIRCUITS.
- EFFORTS SHOULD BE MADE BY CONTROL PANEL DESIGNER AND BUILDER TO SEPARATE HIGH AND LOW VOLTAGE CIRCUITS.
- DAISY-CHAINED CIRCUITS, WHERE SHOWN ON SCHEMATIC, ARE FOR SCHEMATIC SIMPLIFICATION ONLY AND SHOULD BE AVOIDED IN PRACTICE. PROPER TERMINAL BLOCKS AND DISTRIBUTION SYSTEMS SHOULD BE UTILIZED.
- OVERCURRENT DEVICES MUST BE WITHIN 7" OF WIRE LENGTH OF POWER SOURCE.
USE RELAY BOARDS WITH LOW-CURRENT INPUT CIRCUITRY (<5mA). FOR 12V ACTIVE HIGH RELAY BOARD, USE MODEL WHICH ACCEPTS 5V INPUTS SUCH AS ELECTRONICS SALON BRAND. OTHERWISE, USE 5V ACTIVE HIGH RELAY BOARD WITH 5V POWER SUPPLY OR 12V ACTIVE LOW VERSION AND SELECT 'ACTIVE LOW' IN BRUCONTROL DIGITAL OUTPUT ELEMENT. ENSURE RELAY CONTACTS ARE RATED FOR VOLTAGE AND CURRENT REQUIRED FOR APPLICATION. DELETE OR DUPLICATE RELAY OUTPUT CHANNELS AS NEEDED FOR APPLICATION.
- DESIGNER MAY DELETE OR DUPLICATE COMPONENTS AS NEEDED FOR APPLICATION, BUT MUST ENSURE CIRCUIT MAXIMUM IS NEVER EXCEEDED.
- PROPER PRECAUTIONS MUST BE TAKEN TO ENSURE ACCESSORIES DO NOT EXCEED CIRCUIT MAXIMUM.
- LEDS ON SCHEMATIC ARE 240 VAC. CONSOLE MAY BE IN THE SAME OR DISCRETE ENCLOSURE.
- FOR RTD SENSORS (Pt100), WIRE MULTIPLE (<=4) W/ DISCREET MAX31865 AMPLIFIERS AS SHOWN. LOCATE MAX31865 AMPLIFIERS AS CLOSE TO ARDUINO MEGA AS POSSIBLE.
- FOR THERMISTOR SENSORS (10k NTC), WIRE MULTIPLE (<=16) VIA FILTER/DIVIDER CIRCUIT OR WITH TF-3 BOARD AS SHOWN. NOTE TF-3 SUPPORTS UP TO 6 THERMISTORS EACH.
- FOR 1-WIRE SENSORS (DS18B20), WIRE MULTIPLE (<=10) IN PARALLEL AS SHOWN.
- MAX CURRENT DRAW OF 5V SUPPLY FROM ARDUINO MEGA IS 200mA. A DISCRETE 5V POWER SUPPLY SHOULD BE USED FOR ANY DEVICES WHICH WILL EXCEED THIS LIMIT.

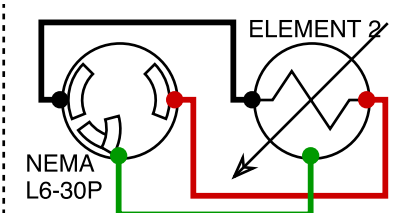
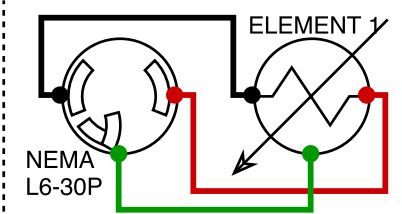
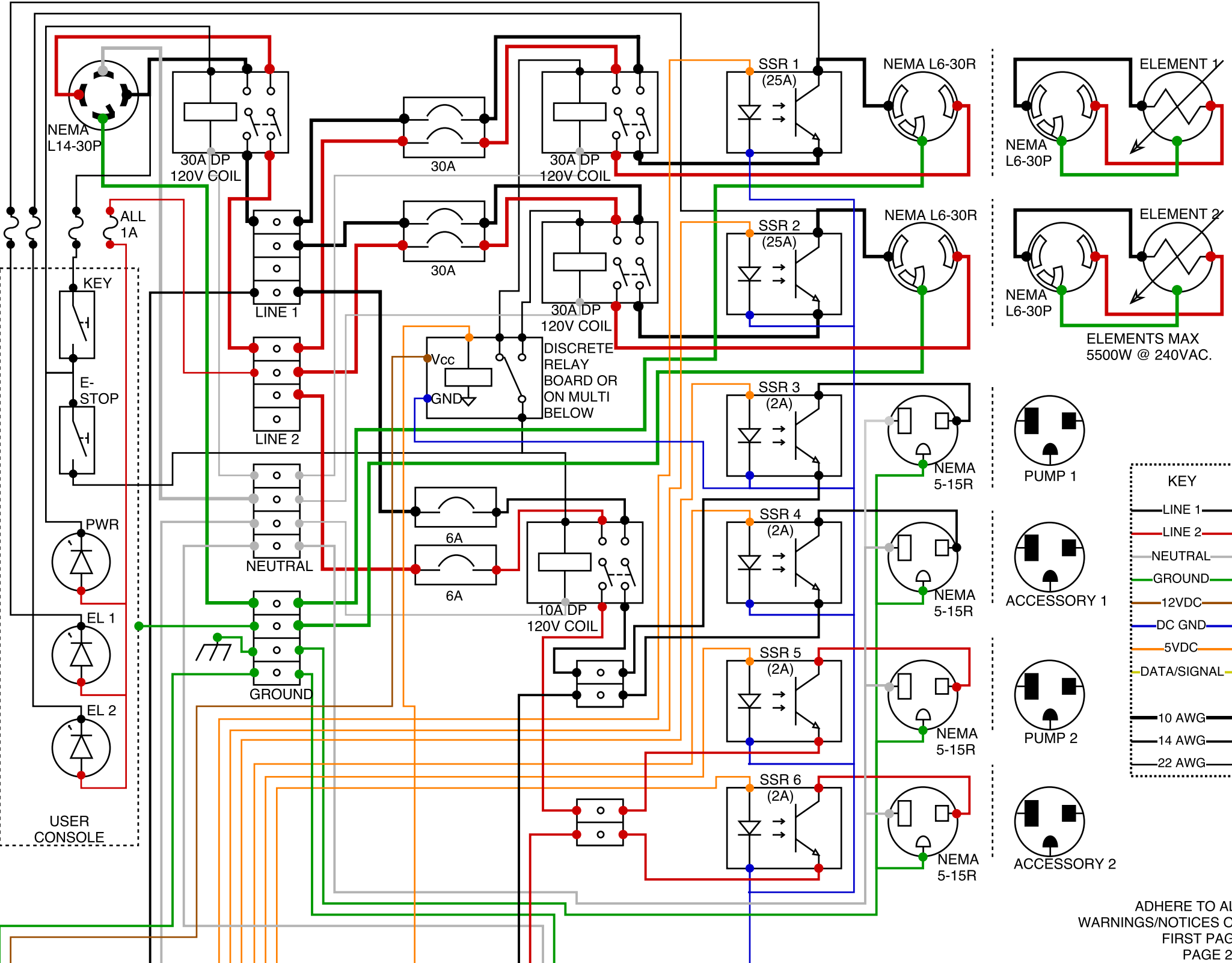

ELEMENTS MAX
5500W @ 240VAC.

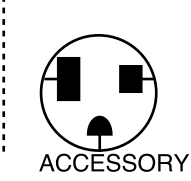
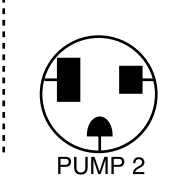
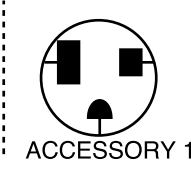
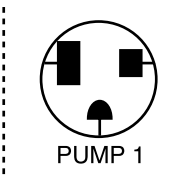

KEY	
	LINE 1
	LINE 2
	NEUTRAL
	GROUND
	12VDC
	DC GND
	5VDC
	DATA/SIGNAL
	10 AWG
	14 AWG
	22 AWG

ADHERE TO ALL
WARNINGS/NOTICES ON
FIRST PAGE
PAGE 2/3

